

# DELTA MEMBRANE SYSTEMS LTD PODIUM DECKS

Date: August 2019

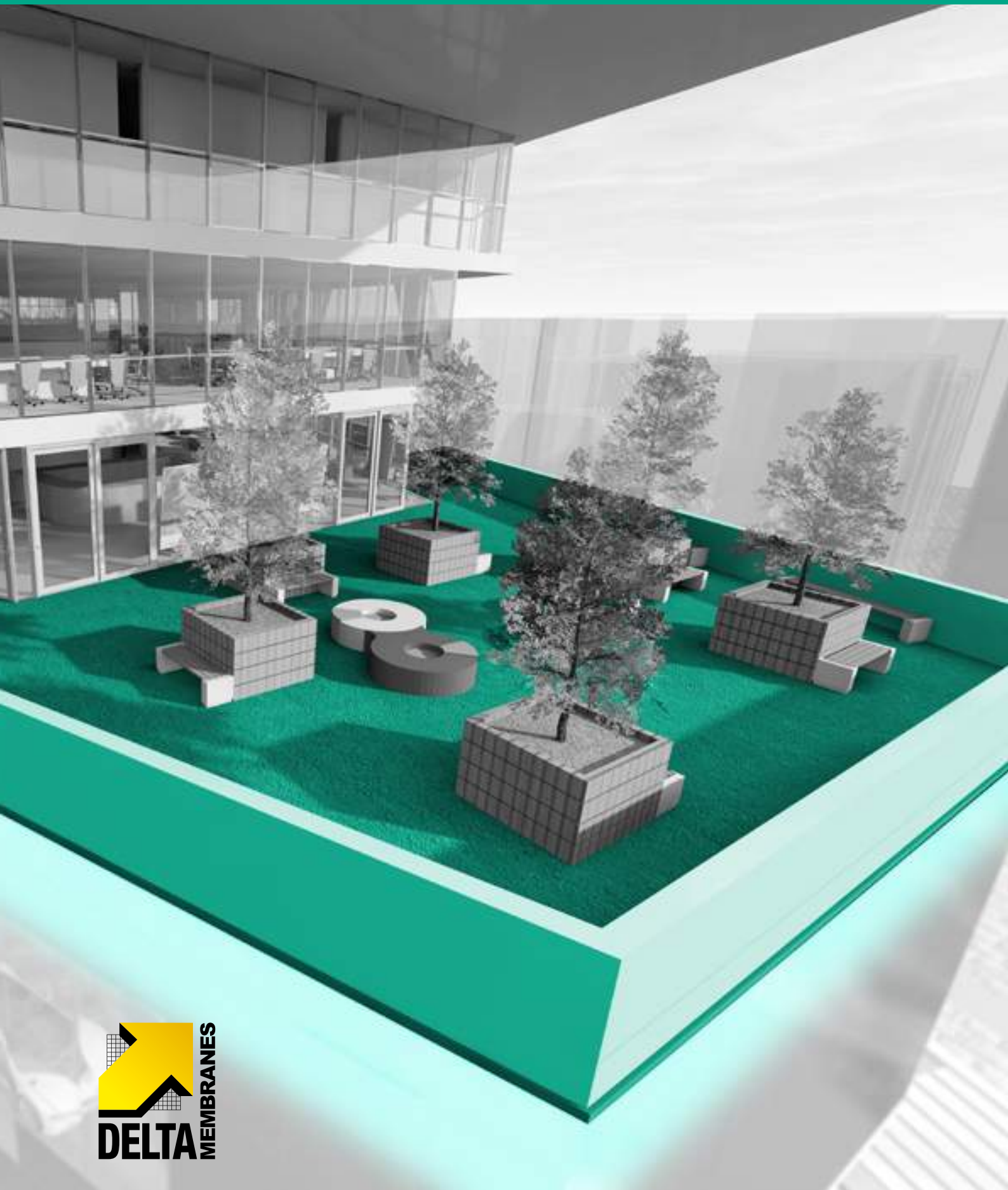

# CONTENTS

---

DELTA MEMBRANE SYSTEMS	03
A DELTA SOLUTION	04
SERVICES	05
PROJECTS	06
STANDARDS	07
WATERPROOFING DESIGN	08
DESIGN AND BUILD PHILOSOPHY	09
DEFINITIONS OF STRUCTURE	10
CHOICE OF STRUCTURE	18
SELECTION OF WATERPROOFING	20
KOSTER PRODUCTS	23
ANCILLARY PRODUCTS	27
SELECTION OF DRAINAGE PROTECTION	30
DRAINAGE PROTECTION SYSTEMS	32
TESTING AND MAINTENANCE	36
DETAILED DRAWINGS	37
DELTA APPLICATION	42
KOSTER APPLICATION	43

---

# DELTA MEMBRANE SYSTEMS

---

Delta Membrane Systems Limited is the leading Type C Cavity Drain Membrane manufacturer in the United Kingdom. Our extensive range of waterproofing and damp proofing products are suitable for basement drainage and structural waterproofing (both for new build and existing structures) and in flood resilience.

Installing a Delta Membrane System offers complete protection to structures from ground water ingress and contaminants. Our products comply with British Standard 8102:2009 and are BBA Certified. Our dedicated technical team offer knowledge and experience in waterproofing design solutions, provide on-site assistance and advice throughout a project.

- Type C Drainage Protection in accordance with BS 8102:2009
- BBA Approved
- Suitable for new, existing and retrofit basement projects
- Ability to easily deal with aggressive ground water conditions
- "Grade 3" performance level (no dampness or water penetration acceptable)
- "Air Gap" Technology
- A reversible system, which will not create damage to historical or heritage structures
- Flexibility to cope in structures where movement or vibration issues can be problematic
- Virgin high density polyethylene studded/moulded sheet (HDPE)
- Easily applied to a variety of different substrates
- An effective barrier to the transmission of salts, liquid water and water vapour
- Suitable for Flood Resilience



# A DELTA SOLUTION

BS 8102:2009 (Code of Practice for Protection of Below Ground Structures Against Water from the Ground) recommends that every Design Team should incorporate a Waterproofing Design Specialist.

Delta Membrane Systems Limited has a dedicated team of Waterproofing Design Specialists. Our trusted Technical Team offer knowledge and experience and are able to provide expertise in structural waterproofing. As a Waterproofing Specialist Manufacturer, we work with architects, surveyors, contractors and engineers alike to provide a design service which complies with BS 8102:2009 and offers the highest level of technical expertise and assurance.



## BELOW GROUND WATERPROOFING SOLUTIONS FOR:

- Residential Buildings
- Commercial Buildings
- Retail Units and Warehouses
- Leisure Facilities
- Archives/Libraries/Vaults
- Hospitals
- Schools
- Underground Rail Stations and Tunnelling
- Underground Car Parking areas
- Listed Buildings
- Heritage Buildings
- Insulated formwork Construction



# SERVICES

## SERVICES

Delta Membrane Systems Limited provides a full range of waterproofing solutions suitable for all new, retrofit and refurbishment construction. With over 125 years of manufacturing experience Delta is an impeccable partner on every project. Our skills have been mastered through experience in the waterproofing industry. Delta's trusted Technical Team will offer assistance from concept to completion. Our hands-on approach and knowledge is what sets us apart.



### DESIGN SUPPORT

- Architecture knowledge
- Concept and waterproofing solutions
- Advice on design and best practice
- Custom solutions, as each project is unique in requirements
- Qualified CSSW staff (named on the Waterproofing Design Register)



### SPECIFICATION SUPPORT

- Detailed drawings including CAD
- Watertight and locking down structure concepts
- Specifications
- BIM
- NBS Plus
- RIBA Product Selector



### SITE SUPPORT

- Training and guidance offered at every step
- Technical Team attendance at site meetings
- Knowledge and experience
- Troubleshooting solutions



# PROJECTS

---

There are many different approaches to structural waterproofing. The construction methods will in part contribute to the specification of types of waterproofing systems and may also determine the overall structural waterproofing strategy.

Structural waterproofing falls into 3 categories:

**Type A** – Barrier Protection

**Type B** – Structurally Integral Protection

**Type C** – Drained Protection

With 3 grades:

**Grade 1** – Some water seepage and damp are tolerable depending on the intended use

**Grade 2** – No water penetration is acceptable

**Grade 3** – No dampness or water penetration is acceptable

## Residential/Commercial Basements



## Car Parks



## Museums and Heritage



## Hospitals



## Schools



## Hotels



## Infrastructure Projects



## Railway and Tunnelling



## Libraries



# STANDARDS

## BRITISH STANDARDS

Standards define best practice.

A standard is an agreed way of doing something. It could be about making a product, managing a process, delivering a service or supplying materials – standards can cover a huge range of activities undertaken by organizations and used by their customers.

## WHAT DOES A STANDARD DO?

Standards are knowledge. They are powerful tools that can help drive innovation and increase productivity. Standards within the Construction Industry enhance consumer protection and confidence.

THE BENEFITS OF USING BRITISH STANDARDS BS 6229:2018, NHBC Chapter 7.1:2010, BS 8102:2009

BS 6229:2018 (Code of practice for Flat roofs with continuously supported flexible waterproof coverings) describes best current practice in the design, construction, care and maintenance of roofs with a flat or curved surface, at a pitch not greater than 10 degrees to the horizontal, with a continuously supported flexible waterproof covering. The supporting structure is either dense and heavy (such as a concrete slab), or consists of framing members supporting a lightweight deck of metal or of timber-based material.

BS 8102:2009 BS 8102 (Code of practice for protection of below ground structures against water from the ground) gives recommendations and provides guidance on methods of dealing with and preventing the entry of water from surrounding ground into a structure below ground level.

## IT COVERS THE USE OF:

- Waterproofing barrier materials applied to the structure
- Structurally integral watertight construction
- Drained cavity construction.

It also covers the evaluation of groundwater conditions, risk assessment and options for drainage outside the structure. It applies to structures which extend below ground level and those on sloping sites.



## NHBC CHAPTER 7.1:2010 OFFERS A CHOICE OF STRATEGIES:

- Design Standards
- Statutory Requirements
- Loadbearing Structure
- Principles of Design
- Structural Deck
- Thermal Insulation and vapour control layers
- Waterproofing and surface finishes
- Rainwater Drainage
- Guarding to Balconies
- Access for Maintenance
- Provision of Information

# WATERPROOFING DESIGN

---

## WHAT IS A WATERPROOFING DESIGN SPECIALIST?

A Waterproofing Design Specialist provides expertise in structural waterproofing. Identifying a Waterproofing Design Specialist can be difficult and daunting. A Waterproofing Design Specialist should have:

- CSSW as a minimum standard of qualification
- Be able to list the principal considerations for a robust waterproofing design
- Offer knowledge on waterproofing systems available
- An in-depth understanding of BS8102:2009 and its requirements
- Desk top study & risk assessment knowledge – these should form part of any Designers Report and Waterproofing Design
- An understanding of sources of water (such as how it flows through the soil and interacts with the structures).
- Structural knowledge
- Knowledge of Ground Gases
- Geotechnical knowledge (to be able to understand the implications of a soil report)
- The ability to produce a Design Report, Method Statements and Waterproof Design drawings.
- With the right products and systems, these long-lasting balconies and terraces can be designed and installed for year-round enjoyment.





# DESIGN AND BUILD PHILOSOPHY

Podium Decks, buried roofs, balconies and terraces all must withstand the comparable combined stresses imposed due to being both externally exposed and trafficked.

Recent years have seen a significant increase in waterproofing failures. Products do not fail. When failures occur, it is due to the design and build philosophy not being correct. The devil is in the detail - all waterproofing elements must be considered at the construction design stage to be durable and effective.

One of the primary requirements of waterproofing design is the prevention of water ingress and the management of water and water vapour movement through and out of a structure. This ethos is identical for any below ground areas of a structure.

What can be done to make waterproofing designs more robust? By influencing the design by advising Architects, Specifiers, Engineers and Contractors on suitable and appropriate materials and to offer an understanding on why details are so important in waterproofing design, along with installation techniques.

## DETAILS

Most waterproofing failures are due to details not being correctly addressed. Details is a very broad term from service penetrations to vent pipes, from down pipes to detail interface between decks and perimeter.

### DETAIL CONSIDERATIONS:

- Type and form of construction
- Site Inspection
- Design compliance
- Structural movement
- Drainage arrangements
- Type of surface
- Concrete surface condition
- Moisture
- Temperature
- Contaminates
- Surface preparation prior (such as treatments, coatings and laitance)

### USE A DELTA REGISTERED INSTALLER

It can be bewildering knowing who to trust for sound advice and service. Choose a Delta Registered Installer and you have the peace of mind that you are dealing with a reputable contractor who works to Delta's stringent standards.

As leaders in the education and training of installers, combined with the Delta's strong influence over legislation, regulations and policies you can feel reassured that a Delta Registered Installer has undergone thorough practical and theoretical training and assessment and has demonstrated that they have achieved the required level of expertise in order to receive this accreditation.



# DEFINITIONS OF STRUCTURE

---

## PODIUM DECKS

A podium deck is one that is raised above the general level of its surroundings.

A podium deck can be used as an infill between and/or attached to buildings structure. A podium deck can also be an elevated platform or one that has a void underneath it. A podium deck may have supporting columns that do not pass through this structural element. Many contemporary buildings incorporate Podium Decks or Plazas into design. These can be utilised for basement car parks, leisure spaces, balconies, patio terraces and gardens.

It is vital the correct waterproofing system is selected when waterproofing Podium Decks, it is essential to know the usage of the building elements below as there may be different grades of waterproofing required as defined in BS8102:2009 (Table 2 - Grades of Waterproofing Protection).

Design is a key element in each type of construction.

## REINFORCED CONCRETE

Podium decks constructed of reinforced concrete which have been correctly designed by an engineer have proven the most reliable method. A stable substrate is essential in all cases. Risk for minor movement, vibration or flexing should be factored into design.

## PRE-CAST CONCRETE

Podium decks constructed of pre-cast concrete and block and beam floors are problematic to waterproof successfully. Adequate falls and drainage discharge points offer a uniform floor to accept waterproofing systems.



# DEFINITIONS OF STRUCTURE

---

## BURIED ROOFS

Buried roofs should not be confused with Podium decks, green roofs or other forms of suspended roof construction types.

Buried roofs are typically part of an under-garden structure or landscaped area, a buried roof is either part of a basement that extends beyond the line of the main elevations, or an elevated deck accessible by people or traffic. Many London Boroughs insist on a minimum 1 metre of soil coverage.

Waterproofing buried roofs can be challenging due to the number of complexities from detailing to construction materials. For example, if it's a landscaped roof the highest risk for leakage is irrigation and drainage penetration.

Failure and leakage of buried roofs often originates at design stage. Sometimes engineers will specify inappropriate construction materials (from a waterproofing perspective) which can include: block and beam, rib deck, hollow rib etc. and these have proven to be problematic to waterproof successfully. Waterproofing block and beam and other pre-cast individual elements and exposed steel beams have proven especially high risk and subject to failure.

Using a liquid applied waterproofing systems offers a seamless waterproofing solution and are an excellent choice for this type of application since it is flexible, durable, resists the passage of water and easy to apply. Liquid applied waterproofing systems offer an easier and faster reliable seal around penetrations and corners. Effective drainage solutions should eliminate potential for sustained saturation.



# DEFINITIONS OF STRUCTURE

## TERRACE & BALCONIES

Both terraces and balconies face rigours of atmospheric agents (weathering), such as the sun, wind, rain and snow. High thermal variations can lead to movement and cracking. Subsequent rainfall then allows water into these cracks. Frost with freeze-thaw cycling, further increases the size and extent of cracks.

Untreated cracks in terraces and balconies can damage the fabric of the building and if not repaired, can become costly structural damage. When selecting waterproofing materials for balconies and terraces consideration should be given to high performance characteristics. Not only must the material have the capacity to guarantee waterproofing, it should also increase the durability of the structure.

In waterproofing applications, attention to details makes all the difference. Railings, drains, channels, fillet joints between horizontal and vertical surfaces and joints in general are critical points which should not be overlooked.

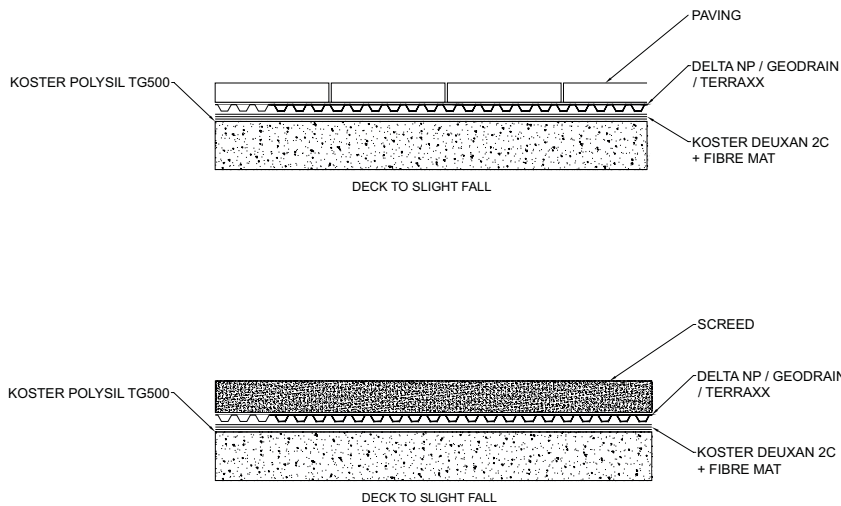

# DEFINITIONS OF STRUCTURE

## CAR PARK

The use of a waterproofing system is essential to extend the design life of car parking facilities. Car Parks are exposed to oil and diesel spills, carbon dioxide gasses and water, all of which become a problem in concrete. Over time these influences can lead to structural damage and waterproofing failures.

BS 8102: 2009 Code of Practice for the Protection of Below Ground Structures Against Water from the Ground defines 4 Grades of basement. Car Parks are listed as Grade 1, basic utility (excluding electrical equipment).

Mechanical impact and abrasion are factors which should be considered when designing a robust waterproofing solution. Use of a waterproofing system which offers crack bridging capabilities able to withstand structural movement are a necessity. Rising moisture should also be considered to ground bearing slabs. Modern car parks must also satisfy stringent health and safety regulations, especially in terms of slip and skid resistance, as well as offering design flexibility.

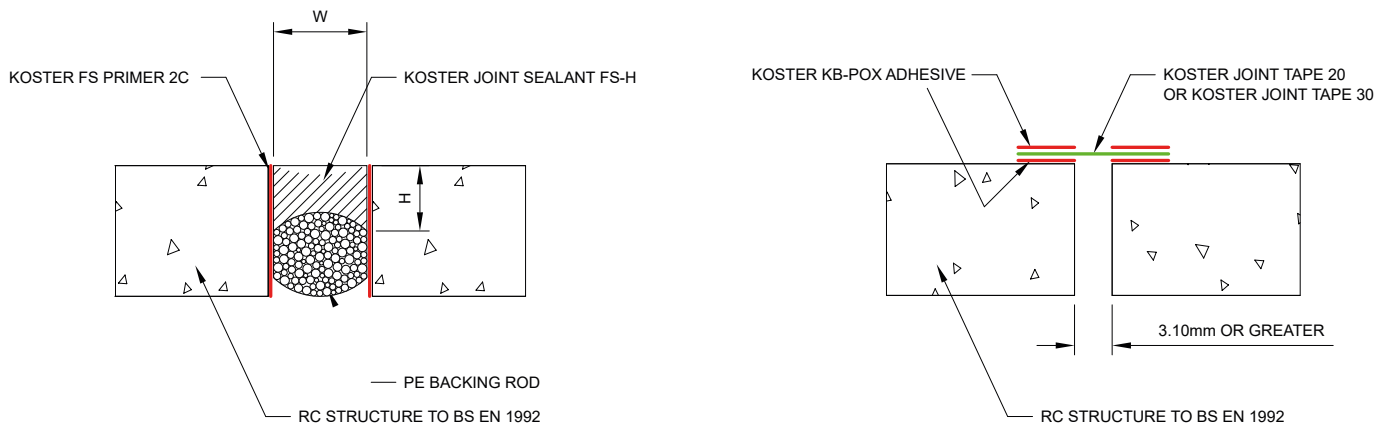

# DEFINITIONS OF STRUCTURE

## WARM ROOF

The warm roof or warm deck structure function of the building and it is intended used, are the main drivers when selecting the right waterproofing system. The structural waterproofing possibilities are as varied as the structure requirements. A warm roof or warm deck is a type of roof construction which has an insulation layer above the rafters and immediately below its waterproofing system. A warm roof construction has many benefits over a traditional 'cold roof', essentially it is a 'breathable roof construction', which allows moisture to escape which in turn prevents damp and any associated decay problems. A warm roof construction allows heat to be conserved within a property – without the need for a ventilation system.

A warm roof or warm deck can be very simple to install and offers higher thermal performance at the cost of a higher roof profile.

Warm roof or a warm deck is thermally efficient and cost effective  
Technical challenges include considering structural loads.

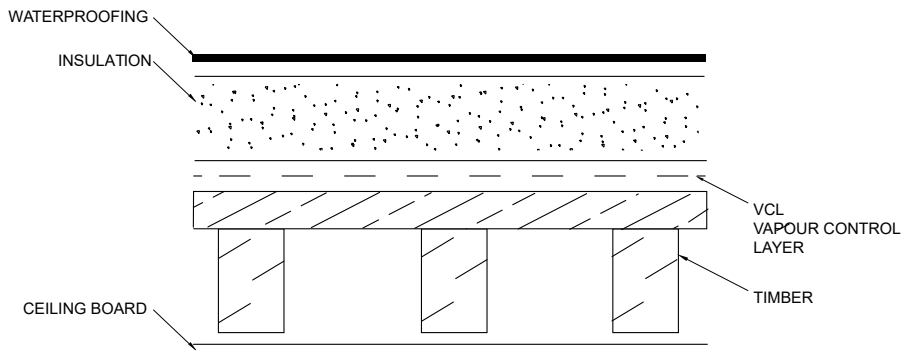

## COLD ROOF

A cold roof or cold deck construction has a thermal insulation layer below the structural deck (everything below the insulation is warm). The concept of a cold roof is usually concerned with roof structures which include an independent ceiling enclosing an air space between the deck and ceiling and incorporate a vapour control layer.

How a building is used and constructed are key factors in the selection of the correct construction materials and waterproofing system - the options are as varied as the requirements and all must meet current UK Building Regulations. Waterproofing solutions should be designed for the most complex building forms. Cold roof waterproofing solutions can be applied using a variety of techniques.

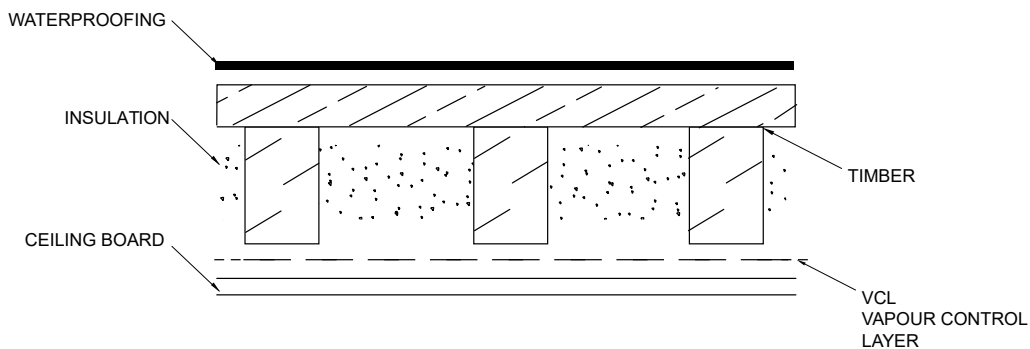

# DEFINITIONS OF STRUCTURE

---

## GREEN ROOF (EXTENSIVE/INTENSIVE)

The positive effects that green roofs have on buildings, people and the environment are incomparable to any other building concept.

The most common green roof structures can be classified as:

- Extensive vegetation
- Simple intensive vegetation
- Intensive vegetation
- Green roofs can be grown on any type of pitch of roof, however structures with a pitch of more than 9.5° will require specific design requirements, in order to retain water and substrate across the surface

Waterproofing systems are paramount to the success of a green roof. It has a fundamental requirement to prevent water ingress into a building and resist damage to the structure from root penetration. The waterproofing system should also be able to provide a thermal performance, roof drainage, air tightness and vapour control to the building.

A green roof construction involves a series of functioning layers that, while retaining the necessary water to support the plants, allow excess water to drain off and protect the roof surface from plant roots and mechanical damage.

Waterproofing technologies allows the correct specification of green roof systems to suit the criteria of the green roof project based on the choice of landscaping, performance and robustness required.



# DEFINITIONS OF STRUCTURE

## BLUE ROOF

A blue roof is a radical rethink in roof drainage; the emphasis is switched to utilising the space to provide attenuation capacity rather than quickly moving the water elsewhere.

A blue roof is an ideal solution for urban areas where options for attenuation capacity is limited and in particular where construction is being carried out within flood risk areas.

A blue roof system has no moving parts, is simple to install and easy to maintain. It is designed to slow/control the rate and release rainwater into the drainage system and to discharge the water completely over a set period of time incorporating variable discharge rates. Keeping the flow off the structure within set levels.

Blue roofs are particularly beneficial for:

- Schools
- Hospitals
- Leisure Facilities
- Properties in flood risk areas
- Domestic
- Commercial

The adoption of SuDS (a sustainable drainage system) within legislation forces designers to pay more attention to how rainwater is managed. There are many techniques available but the provision of attenuation within the site remains a central tenet in the design.

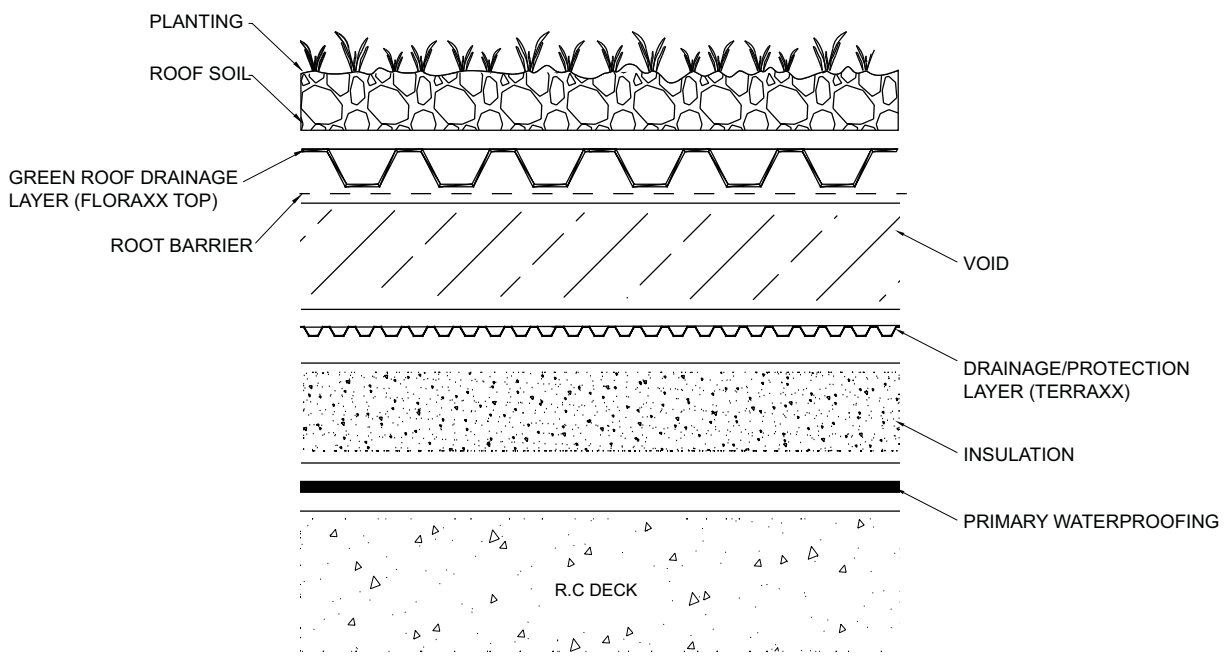



# DEFINITIONS OF STRUCTURE

## HYBRID MULTIUSE

A Hybrid deck is a combination of two or more systems.

Where there are different external uses, different internal uses below the deck, where there is a need to combine sections of warm roof and cold roof type construction reflecting the location and uses of the decks. Also reflecting the different areas of use on a deck – blue roof, extensive green roof, hard landscaping all requiring design and detailing.

Some projects will require a combination of waterproofing systems to offer optimal structural protection against water ingress. The structural waterproofing possibilities of a hybrid deck will be as varied as the structure requirements.

When specifying a hybrid deck use of the structure below is taken into consideration as well as the intended use of the structure above. A Hybrid deck may have two or more functions above ground level as well as two or more functions below ground level.

A Hybrid deck can combine the waterproofing systems for:

- Podium Decks
- Buried Roofs
- Terraces & Balconies
- Car Parks
- Warm Roofs
- Cold Roofs
- Green Roofs
- Blue Roofs

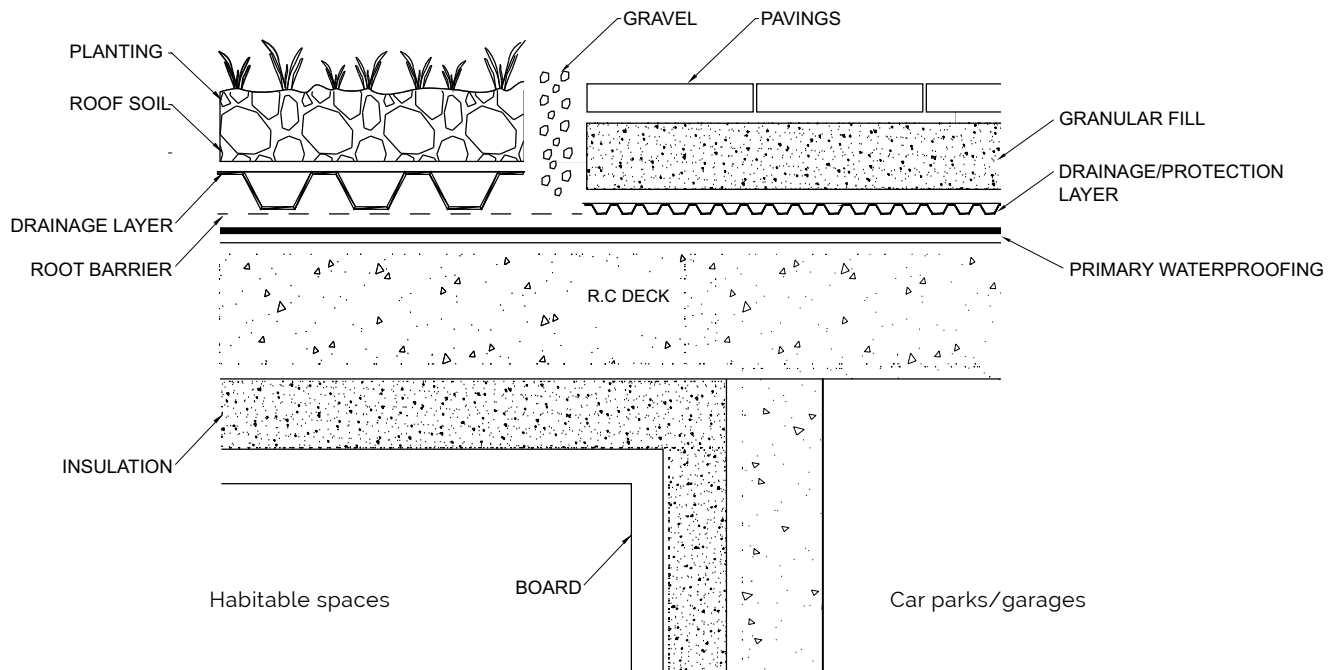

# CHOICE OF STRUCTURE

## IN-SITU CONCRETE

Cast in situ concrete is appropriate for all types of basement construction. In situ concrete is a common form of basement construction for residential use, due to its relatively simple application, adaptability and cost. In-situ concrete is often the only appropriate form of construction for retrofit basements under existing properties, due to its relative ease of placement on site.

The concrete must be allowed to cure to the necessary strength before loads, such as partition walls, are applied.



## PRECAST CONCRETE UNITS

Precast concrete is a construction product produced by casting concrete in a reusable mould or "form" which is then cured in a controlled environment, transported to the construction site and lifted into place ("tilt up").

By producing precast concrete in a controlled environment (typically referred to as a precast plant), the precast concrete is afforded the opportunity to properly cure and be closely monitored by plant employees. Using a precast concrete system offers many potential advantages over onsite casting. Precast concrete production can be performed on ground level, which helps with safety throughout a project. There is greater control over material quality and workmanship in a precast plant compared to a construction site. The forms used in a precast plant can be reused hundreds to thousands of times before they have to be replaced, often making it cheaper than onsite casting when looking at the cost per unit of formwork.

## BEAM & BLOCK

The system comprises a series of inverted T-beams made of pre-stressed concrete, which look remarkably similar to train rails in profile.

These beams are cut to a specified length – determined by the construction drawings. On site, they are laid perpendicular to the supporting blockwork walls that make up the inner leaf of the footings (at ground floor level). The rails rest on a damp-proof course and have a 100mm bearing; in other words, they cover the whole width of that inner leaf of blockwork.

The beams are laid at suitable centres to allow them to be filled with standard-sized lightweight air crete or dense aggregate blocks, until the whole slab area is covered. The floor structure is then brushed over with a 4:1 dry mix of sharp sand and cement to fill the gaps. Each installation will be tailor-made to suit the project by the supplying company.



# CHOICE OF STRUCTURE

---

## RIBDECK

The Type B Wide Rib is the industry standard for corrugated industrial roofing and is as popular for floor decking. It can be produced in galvanized steel, painted steel, aluminium and stainless steel. The wide rib allows for a narrow top opening, which is desired when rigid insulation is to be used on top of the deck.



## TIMBER

Timber construction is traditional methods of building with heavy timbers, creating structures using squared-off and carefully fitted and joined timbers with joints. A common-used method for constructing timber frames is the platform frame, in which each storey is formed by floor-to-ceiling timber panels and a floor deck which then becomes the platform for constructing the next storey. Timber construction is widely used throughout the United Kingdom and is a traditional roofing skill, to waterproof a timber construction we would always recommend a Waterproofing Design Specialist be consulted from the earliest stage of the project.



# SELECTION OF WATERPROOFING

Successful podium deck and buried roof waterproofing design lies with choosing the most appropriate combinations of structure and waterproofing system to achieve pre-determined performance levels and criteria. In order to design out risk of failure due to less than adequate workmanship, damage or defects on site it is also important to consider practicality and ease of installation, the phasing of the construction process and the scope for testing and certifying during construction.

Common deck structures include in situ concrete, beam and block, pre-cast units, steel rib-deck and timber. Although in situ reinforced concrete is seen as being the most integrally water resisting structure and the most amenable to facilitate leak repair there will be sound reasons on certain projects why beam and block, rib deck, pre-cast units or timber will be favoured instead. Different types of structures feature varying ancillary details and physical characteristics such as thermal expansion, frequency of construction joints and structural interfaces, propensity for distortion, planned expansion or movement joints and so on. These will need to be addressed by the waterproofing system.

Setting aside how the overall structure will influence selection of the waterproofing system there will be additional considerations such as the presence of planters, upstands, parapet walls, railings, steps, cavity trays, flashings, roof lights and so on and the practicalities of safely incorporating these features within the overall waterproofing design. The usage of the space below the waterproofing system will need to be considered because the disruption attendant upon overhead leakage into a Grade 1 space such as a car park or utility area is far less serious than overhead leakage into a Grade 3 space such as a restaurant or dwelling. Therefore, a cost versus risk element may be implied and it is the duty of the designer to discuss with the client the advantages of one system versus another, the scope for designing out potential for leakage and the practicalities of repair or maintenance should a leak occur.

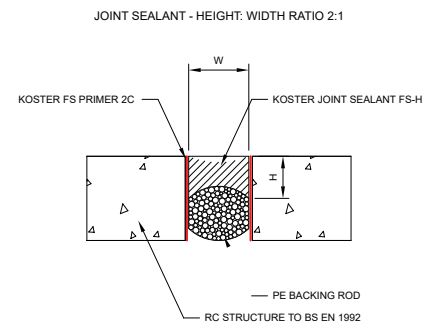

# SELECTION OF WATERPROOFING

Where structures feature multiple construction joints, scope for movement or settlement, deflection due to imposed static or dynamic loads and the waterproofing system cannot be accessed for location and repair of defects and a repair cannot be effected from below, it may be prudent to incorporate a combination of waterproofing systems to design out risk of a leak occurring in the first place. For beam and block construction for example, a concrete topping to falls may be installed upon the structure to provide a smooth reinforced substrate which will help with drainage and will lend itself to the smooth and consistent application of products. Products which have crack bridging capabilities, durability and compatibility when applied one over the other are particularly suitable.

The importance of attention to detail at perimeter upstands, fillets, service penetrations and the like cannot be overstated. Waterproofing systems which are seemingly straightforward to apply over large expanses of smooth deck are only as good as the detailing and application standards at the most awkward corner or upstand and they are only as effective as the way they have been designed to link with the cavity tray DPC, roof light upstand or flashing detail.

In summary, it is the duty of the waterproofing designer to assess a variety of factors and variables simultaneously and to come to a logical and balanced decision regarding the design. Working as part of the design team and keeping abreast of changes, revisions and updates to the project is important because these could have a bearing upon the environmental, structural and other stresses that may be imposed upon the waterproofing system and adaptations may need to be made. Ensuring proper training, application expertise, certification and testing procedures on the part of the installing contractor is critical. Whether the proposed construction is warm roof, cold roof, green roof, blue roof or a combination of types the principles stated here will apply in equal measure to achieve a successful long-term outcome.

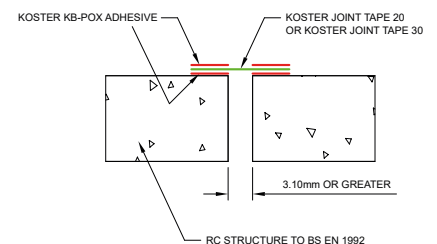

# SELECTION OF WATERPROOFING

CHART 1: SUBSTRATES

SUBSTRATES	DEUXAN 2C	NB 4000	KOSTER 21	FLEX FOIL	NB1 GREY	KSK	KBE LIQUID
Timber			✓	✓		✓	✓
Reinforced Concrete	✓	✓	✓	✓	✓	✓	✓
Beam & Block							
Ribbed Deck	✓	✓	✓	✓	✓	✓	✓
Over Insulation	✓			✓		✓	✓
Concrete Plank							

Decks should ideally be laid to falls away from building (fall s/be 1:100)

CHART 2: PRODUCT CHARACTERISTICS

CHARACTERISTICS	DEUXAN 2C	NB 4000	KOSTER 21	FLEX FOIL	NB1 GREY	KSK	KBE LIQUID
Protection Required							
UV		✓	✓	✓	✓	✓ not long term	
Elongation	100%					250%	900%
Crack Bridging	✓	✓	✓	✓	✓	✓	✓
Working Temperature	+5 to 35°C	+2 to 35°C	+5 to 35°C	+5 to 35°C	+5 to 35°C	+5 to 35°C	+5 to 35°C
Trafficability			Light	Light	Light		

For further information please read Technical Data Sheets

# KOSTER DEUXAN 2C

Koster Deuxan 2C is a robust crack-bridging, 2 component polymer modified bitumen thick film sealant for waterproofing construction. Koster Deuxan 2C is designed for the secure and permanent exterior waterproofing of basement walls, foundations, floorplates and for intermediate waterproofing of Podium Decks, balconies, terraces as well as for wet and damp rooms. Koster Deuxan 2C is also suited for the intermediate waterproofing underneath screeds and for bonding insulation and drainage boards.

- BBA Approved
- Koster Deuxan 2C is satisfactory for use as a fully bonded, Type A Barrier protection waterproofing as defined in BS 8102:2009 for waterproofing of new and existing structures
- Positive and negative side waterproofing against pressurized water
- Priming is not necessary on polystyrene substrates – Such as ICF Construction
- Can be used internally and externally on concrete, brickwork, blockwork or masonry, or as a dampproof and waterproof membrane for solid floors and tanking below ground to provide an effective barrier to the transmission of liquid water where Grades 1 to 3 waterproofing protection is required, as defined in Table 2 of BS 8102:2009
- Impervious to water and will act as a waterproof layer
- Easy application
- Seamless application
- Suitable for new construction and repair on existing structures
- Suitable for waterproofing basements (exterior or interior horizontal and vertical surfaces)
- Possess excellent pressure and abrasion resistance

## SPECIFICATION

NBS Specification  
 J30 Liquid applied damp proofing  
 110 Cold Applied Tanking  
 130 Cold Applied Damp Proofing  
 J31 Liquid applied waterproof roof coatings  
 353 Waterproof Coating

## PRODUCT CODE

DMS 169

## COVERAGE RATES

5.1m<sup>2</sup> (2 Coat application using 6mm notched trowel) Consumption add powder to the liquid and mix for 3 Minutes. (Use anchor paddle for mixing) application thickness 3mm per coat (final thickness once cured 4mm).



## TECHNICAL DATA

Material base:	Bitumen/rubber with a reactive powder
Density of the mixture:	1.07 g / cm <sup>3</sup>
Heat resistance:	+ 70 °C
Elongation at break:	approx. 100 %
Waterproof after full cure (in accordance to DIN 1048 part 5):	waterproof up to 5 bar
Curing time at + 20 °C:	approx. 24 hours
Min. temperature during curing:	+ 2 °C
Mixing time:	min. 3 minutes
Pot life:	approx. 90 minutes
Application temperature:	+ 5 °C to + 35 °C
Substrate temperature:	+ 5 °C to + 30 °C
Effectiveness against radon:	gas radon gas-proof



# KOSTER NB 4000

Bitumen free, polymer modified, mineral hybrid coating for the internal and external waterproofing of building structures. Koster NB 4000 cures reliably and quickly also in difficult ambient conditions. The material can be applied from + 2° C upwards, is resistant to rain after approx. 2 hours and can be exposed to pressurized water after 24 hours of curing time. It is elastic, crack bridging and suitable for slightly moist and bituminous substrates. Fields of application: Podium Decks, buried Roofs, basements, foundation plates, masonry and the repair of mineral waterproofing layers.

- Koster NB 4000 is a hybrid product that combines the properties of a polymer modified bitumen thick film sealant and a flexible mineral waterproofing slurry
- For waterproofing building structures inside and outside
- Cures rapidly even in adverse weather conditions – Application temperature from + 2 °C
- Rainproof after approx. 2 hours (Insulation board installation after approx. 4 hours – Backfilling after approx. 24 hours)
- High substrate tolerance; can be applied onto old bituminous or mineral waterproofing systems
- Applicable even on slightly damp surfaces
- Tools can be cleaned with water
- Creamy and homogeneous texture
- Crack bridging up to 0.4 mm; suitable for sealing foundation skirting
- Bitumen-free
- UV resistant
- Paintable and coat able with foundation renders
- Can be spray applied

## SPECIFICATION

NBS Specification  
J40 Flexible Sheet Waterproofing/  
damp proofing  
295 Geocomposite studded cavity  
drainage/venting membrane  
Q37 Green Roofs  
350 Drainage Layer

## PRODUCT CODE

DMS 167

## COVERAGE RATES

6m<sup>2</sup> (2 Coat Application using 6mm  
notched trowel) Consumption add  
powder to liquid and Mix for 3 Minutes.  
(Use anchor Paddle for mixing)  
application thickness 3mm per coat  
(final thickness once cured 4mm).

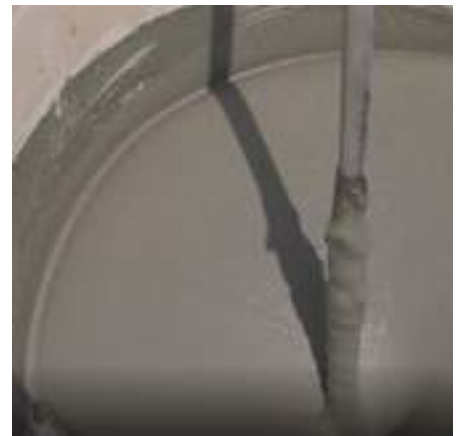

## TECHNICAL DATA

Colour:	Grey
Solids:	90% by weight
Density (+20 °C):	0.95g/cm <sup>3</sup>
Application temperature:	+2°C to +30°C
Working Time:	approx. 45 minutes
Rain Resistant after:	approx. 4 hours





# KOSTER 21

Koster 21 is a 2 component, solvent-free, liquid applied, elastic, crack bridging waterproofing material with excellent adhesion to dry and moist substrates. Koster 21 is liquid applied and seamless, which greatly eases application to complicated architectural details. Koster 21 seals against synthetic oils and aliphatic hydrocarbons with high boiling points (up to 2 bar). Koster 21 does not contain volatile organic compounds (VOC content = 0), is free of polyurethanes, isocyanates, and bitumen.

- Positive side waterproofing
- Fast curing
- Highly flexible
- Easy application
- Seamless application
- Reflects sunlight and reduces building surface temperatures
- Suitable for new construction and repair on existing structures
- Suitable for waterproofing basements (exterior or interior horizontal and vertical surfaces)
- Suitable for indoor and outdoor use
- Not resistant against substances with high aromatic hydrocarbon contents such as benzene, xylene, toluene, etc. In case of questions contact our technical support team.
- Resistant to occasional foot traffic, aging, hydrolysis, UV-rays, frost, and salt
- Once first layer has cured, can be covered with subsequent layers
- Installed sheets should overlap by at least 5 cm

## SPECIFICATION

NBS Specification  
J30 Liquid applied damp proofing  
110 Cold Applied Tanking  
130 Cold Applied Damp Proofing  
J31 Liquid applied waterproof roof coatings  
353 Waterproof Coating

## PRODUCT CODE

DMS 244

## COVERAGE RATES

7m<sup>2</sup> (Based on 2 Coat Application, Anchor paddle to mix. Consumption add powder to liquid can add up to 1.6 litres of water to every 20kg tub. (Mix for 3 Minutes) Application thickness 2mm per coat. (Glass fibre mesh embedded in first wet coat)



## TECHNICAL DATA

Colour:	White
Consistency:	Pasty
Mixing Ratio (by weight):	2:3 (A:B)
Application Temperature:	+5°C to +35°C
Pot life (1kg of mixed material):	45 minutes
Thickness per layer:	0.5mm – 2.0 mm
Crack bridging:	0.4mm
Density:	1.55g/cm <sup>3</sup>
CO <sub>2</sub> permeability:	8.28g/m <sup>2</sup> . 24h



# KOSTER FLEX FOIL

Koster MS Flex Foil is a single component, liquid applied, elastic, crack bridging waterproofing material based on MS polymer technology. It is characterized by its excellent adhesion to a wide variety of building materials. MS Flex Foil can be applied on dry or slightly moist substrates. Koster MS Flex Foil is solvent free and does not contain isocyanates. The fast curing coating is highly flexible, resistant to occasional foot traffic, aging, hydrolysis, UV-rays, salts, and frost.

Koster MS Flex Foil is an ideal waterproofing material for the positive side waterproofing of concrete slabs, flat roofs, terraces or balconies, in wet and damp rooms and similar applications. Due to its excellent adhesion to most substrates (including masonry, concrete, screed, PVC, FRP, Plastics, metal and bitumen) and high elasticity it is an excellent repair material.

- Positive side waterproofing
- Fast curing
- Highly flexible
- Easy application
- Seamless application
- One component
- Fast curing
- Highly elastic
- UV resistant
- Suitable for new construction and repair on existing structures
- Suitable for indoor and outdoor use
- Excellent adhesion to numerous substrates



## SPECIFICATION

NBS Specification J30 Liquid applied  
Tanking/Damp Proofing

## PRODUCT CODE

DMS 228 (8kg bucket)  
DMS 294 (25kg bucket)

## COVERAGE RATES

(8kg) 4m<sup>2</sup> for 2 coat application, (25kg)  
12.5m<sup>2</sup> for 2 coat application.  
(Superfleece embedded in first wet  
coat)

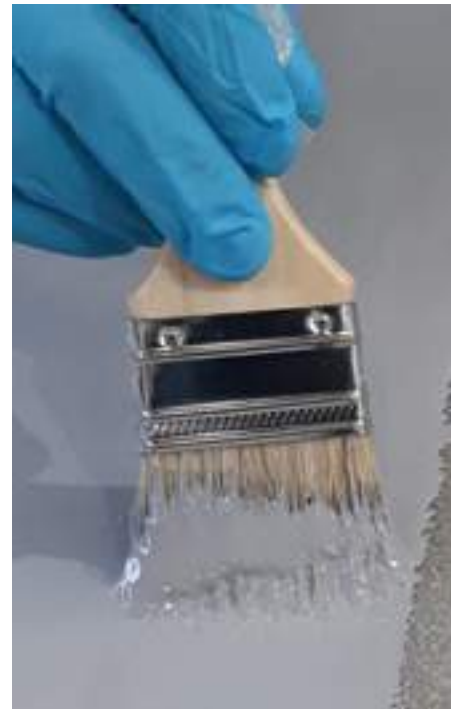

## TECHNICAL DATA

Tensile Strength (+23 °C):	1.3 N/mm <sup>2</sup>
Elasticity:	500%
Application Temperature:	+5°C to +35°C
Service Temperature:	-25°C to + 80°C
Application Thickness:	1.5mm – 2.0 mm
Complete cure after (+23 °C):	24-48 h
Density:	1.5g/cm <sup>3</sup>
Accelerated and weathering test ASTM G154:	unchanged after 5000 h



# ANCILLARY PRODUCTS

---



## KOSTER NB1

### Koster NB1 Grey Waterproofing Slurry

Koster NB1 is a mineral coated waterproofing slurry containing crystallising and capillary-plugging agents. It can be used for waterproofing against ground moisture and for non-pressurized and pressurized water.

- Positive and negative side waterproofing against pressurized water
- Resistant against chlorides, sulphates and phosphates
- Penetrates the surface where crystallization leads to inseparable waterproofing-substrate bond – does not contain corrosion promoting ingredients
- No VOC emissions
- Substrate does not have to be continually kept wet to cure

## KOSTER KSK

Koster KSK SY 15 is a highly tear resistant, 2 layer cross laminated polyethylene foil with plastic bitumen/rubber adhesive and sealing compound. Koster KSK SY 15 can be cold applied. Due to its high ductility Koster KSK SY 15 can easily be applied to difficult details.

- Highly flexible
- Fast setting – immediately waterproof
- Resistant to driving rain
- Crack bridging
- Suitable for waterproofing polystyrene elements
- Suitable for waterproofing balconies and terraces



## KOSTER KBE LIQUID FILM



Koster KBE Liquid Film is a highly elastic, solvent-free sealing compound with a rubber/bitumen basis. Suitable for foundation waterproofing and intermediate waterproofing on horizontal areas such as terraces, balconies, wet and moist rooms (under screeds) in above and below ground construction and garages.

KBE Liquid Film is also suitable for waterproofing floor areas against rising damp.

- Positive side waterproofing against pressurized water
- Waterproofing on horizontal areas
- Applied over plaster or concrete, flush jointed masonry or Koster NB 1 Grey
- Seamless application
- Suitable for new construction and repair on existing structures
- Can be used undiluted in a thin layer as a primer
- Can be applied with a brush, roller, trowel, paint brush or suitable spray equipment

# ANCILLARY PRODUCTS

---



## KOSTER KB FLEX 200

Koster KB-Flex 200 is a permanent plastic sealing compound ideal for sealing pipe and cable penetrations, cavities and for custom detail waterproofing solutions against moisture and pressurized water.

- Waterproof sealing compound
- Watertight finish
- Ideal solution for sealing pipe and cable penetrations
- Does not dry out
- Can be applied to dry, moist or wet substrates
- Immediate functionality
- Can be used internally and externally on concrete, brickwork, blockwork or masonry

---

## KOSTER REPAIR MORTAR PLUS

Koster Repair Mortar Plus is a watertight, fast setting, slightly expanding repair mortar with excellent adhesion (even to old building material substrates). With the addition of Koster SB Bonding Emulsion, it can be used as a PCC (polymer-modified cement concrete) mortar.

- Watertight (Positive and negative side waterproofing)
- Fast Setting (Seamless, easy application)
- Slightly expanding
- Excellent adhesion
- Can be applied to all mineral substrates
- Suitable for watertight repairs and touch ups to substrates
- Can be used internally and externally on concrete, brickwork, blockwork or masonry



## KOSTER POLYSIL TG 500

Koster Polysil TG 500 – is a deeply penetrating primer for damp, salt-containing substrates and an anti-lime treatment for new concrete which also acts as a liquid hardener for sealing slurries. Polysil TG 500 will not only reduce the amount of free lime leaching but will also improve the water resistance of the basement structure by absorption into the structure and locking in the free lime.

- 'anti lime' coating product specially blended with Polymers and silicates
- Brush or Spray application
- Can be used to strengthen and to protect mineral substrates and to reduce their absorptivity, even of such problematic building materials as sandstone
- Decreases the danger of new development of salt efflorescence, free lime egress, and raises the resistance of mineral substrates to freezing and thawing
- Can also be used to harden sealing slurries
- As a surface primer for Koster waterproof Coatings

# ANCILLARY PRODUCTS

---



## KOSTER JOINT TAPE 20

Koster Joint Tape 20 is a thermoplastic tape for sealing expansion and dilatation joints and irregular construction cracks. Koster Joint Tape 20 is UV resistant, highly elastic and can withstand extreme movements. When used with Koster KB Pox Adhesive (a 2 component epoxy based, thixotropic high performance adhesive) a Joint Tape System is created.

- UV Resistant
- Highly elastic
- Ideal for waterproofing horizontal and vertical dilatation joints
- Ideal for waterproofing wide and irregular cracks
- Suitable for concrete, mortar, wood, metal, aluminium, glass fibre reinforced plastics, epoxy mortar, natural and artificial stone and other building materials.

---

## KOSTER FS-V&FS-H

Koster Joint Sealant FS-H is a polysulphide-based elastic, pourable joint sealant for sealing joints in horizontal areas. When fully cured, Koster Joint Sealant FS-H is a rubbery elastic sealant with a high mechanical load capacity, good resistance to water, sea water, salt solutions, benzenes and mineral oils. It is root resistant, does not rot and it has very good retraction properties. Koster Joint Sealant FS-H is designed for horizontal applications.

Koster Joint Sealant FS-V is a flexible stiff/creamy polysulphide joint sealant. When fully cured, Koster Joint Sealant FS-V is a rubbery elastic sealant with a high mechanical load capacity, good resistance to water, sea water, salt solutions, benzenes and mineral oils; it is root resistant, does not rot and it has very good retraction capabilities. Koster Joint Sealant FS-V is designed specifically for vertical applications.



## KOSTER SB BONDING EMULSION

Koster SB Bonding Emulsion is a universally usable synthetic liquid for all cementitious mortars, plasters and sealing slurries. Koster SB Bonding Emulsion is solvent, plasticizer and filler-free. When added to mineral based systems, the synthetic liquid increases elasticity, flexibility, bond strength and reduces water absorption.

- Positive and negative side waterproofing against pressurized water
- Can be used in all cases in which a good bond between mortars, plasters, sealing slurries, concrete and existing mineral substrates
- As an additive to mineral systems, the synthetic additive causes a strong increase in flexibility and elasticity and at the same time a reduction of the water absorption
- Improves the application properties and workability of fresh mortars
- Due to the synthetic additive, cured mortars and plasters become considerably more resistant to frost, salts, and other aggressive substances.

# SELECTION OF DRAINAGE PROTECTION

The selection of the drainage and protection membrane to protect the chosen waterproofing system is critical to long term success. Factors such as the use of the deck area, the consideration of dynamic or static loadings, fall gradients to discharge and frequency of drainage outlets and the maintainability of such are influencing factors.

Where green or living roofs are concerned the choice of membrane may need to be made in conjunction with horticultural requirements to maintain plant health and water storage within the membrane combined with controlled overspill. The choice of membrane may also depend upon whether the green roof is intensive or extensive in nature. Where hardscaped or paved finishes are required then the chosen drainage and protection membrane must be suitable to cope with imposed static or dynamic loads in the form of planters, foot traffic, vehicular traffic or similar and in the case of vehicular traffic can vary between as much as 15cm and 65cm. This brochure contains guidance on the suitability of our range of Delta drainage and protection membranes for a variety of deck uses in the form of the tables below.

**Drainage Capacity After 50 Years Under a Permanent Load of 20 kPA**

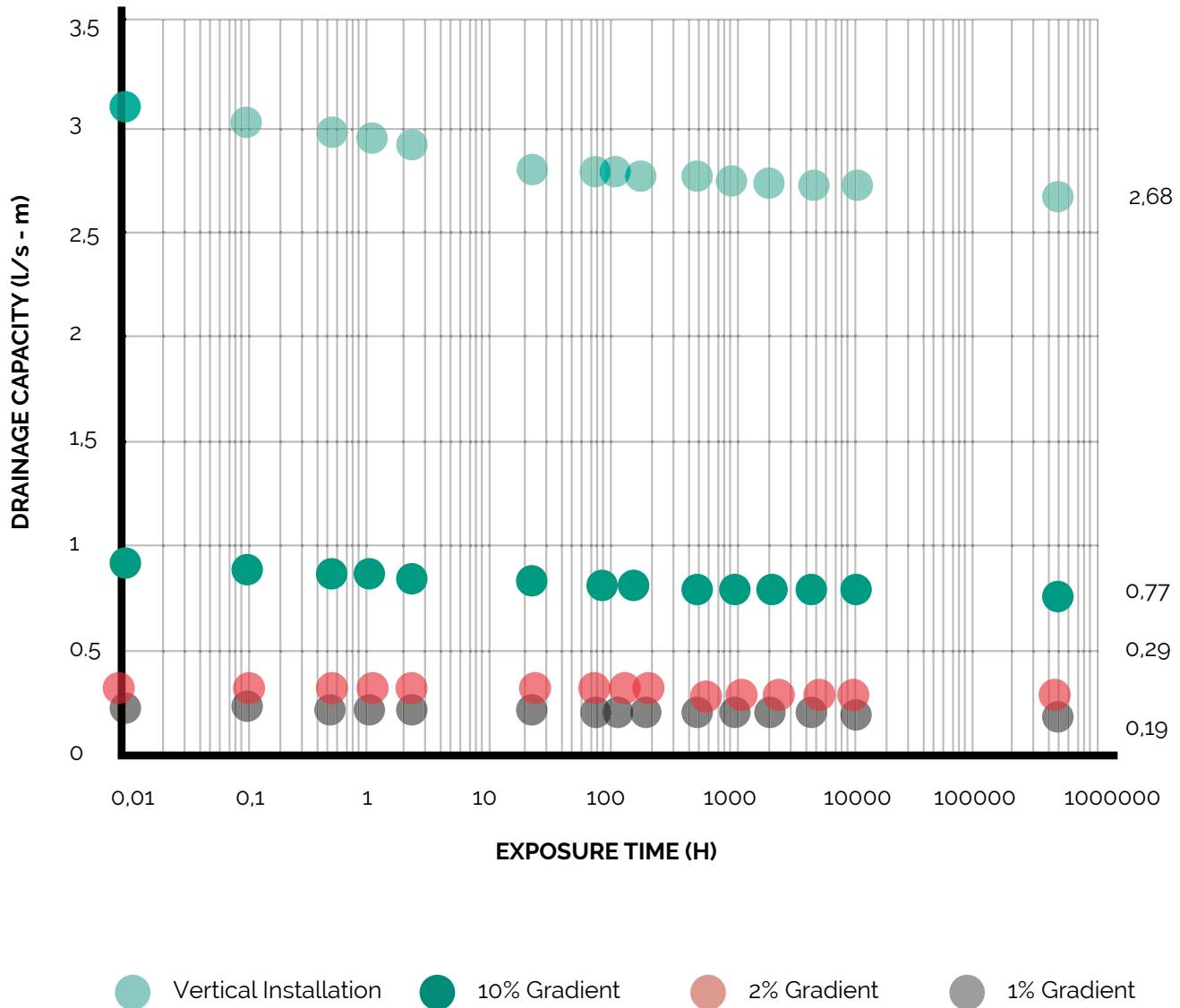

# SELECTION OF DRAINAGE PROTECTION

## IMPORTANT INFORMATION ON HORIZONTAL APPLICATIONS

When integrated in soil-covered ceilings, consideration should be given to the following gradient & drainage-rate characteristics, which apply a load of 20kN/M<sup>2</sup>.

Gradient	Drainage Rates	Drainage Length
2%	0.15 L/(s - m)	16m
3%	0.20 L/(s - m)	22m

After laying, the sheet will bear weight of a wheelbarrow easily when uncovered and that of a wheeled loader when covered at a thickness of 40cm minimum.

Minimum surfacing thickness required to support vehicles:

Vehicle Type	Surfacing Thickness
Passenger Cars	> 15 CM
Trucks 3/3	> 15 CM
Trucks 6/6	> 25 CM
Trucks 9/9	> 35 CM
Trucks 12/12	> 40 CM
Trucks 16/16	> 45 CM
Heavy Trucks 30	> 45 CM
Heavy Trucks 60	> 65 CM

PLEASE NOTE: Where heavier loads are involved, please contact our technical department.

Delta Terraxx Under Herbaceous Cover

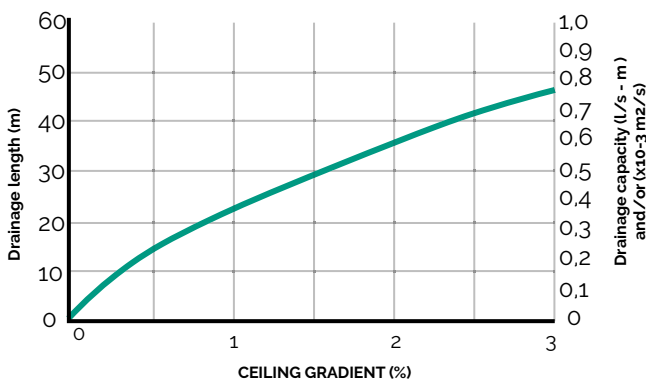

Delta Floraxx Under Herbaceous Cover

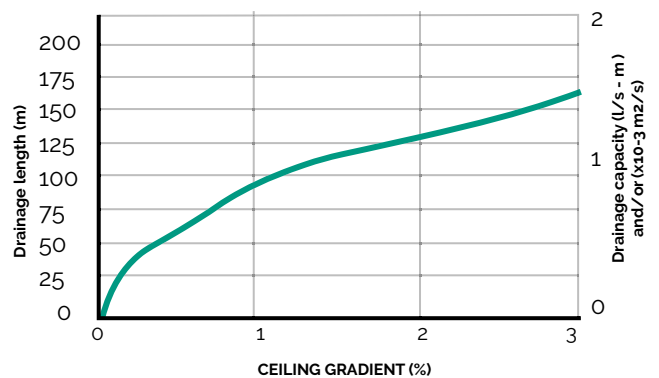

# DELTA GEO DRAIN

Geo-Drain Quattro is a unique drainage protection system/external waterproofing membrane that works in conjunction with Type A External Waterproofing or can simply be used in civil engineering situations. Geo-Drain Quattro is a compact 4-layer membrane which can be used vertically and/or horizontally. Geo-Drain Quattro offers maximum safety for thick viscoelastic coatings and a multitude of alternate Type A systems. This holds true even if driving rain can penetrate through an imperfectly installed upper edge trim. In a watertight system, such rainwater would exert hydrostatic pressure on the waterproof coating. However, the micro-perforated slip film which together with the additional filter cloth, acts as a backup drainage layer behind the dimpled sheet ensures that any water is drained off safely. In addition, the slip film prevents the transmission of movement to the waterproof coating.

- High Compressive Strength
- Suitable for new and retrofit projects
- Flexibility to cope in structures where movement or vibration can be problematic
- An effective barrier to water and water vapour
- Easy Application
- Patent protected
- micro-perforated slip film (together with the additional filter cloth), acts as a backup drainage layer behind the dimpled sheet ensuring that any water is drained off safely
- Slip film prevents the transmission of movement to the waterproof coating
- Unique protection and drainage system offers maximum safety for thick viscoplastic coatings
- Resistant to chemicals, root penetration, rot proof
- Keeps water from accumulating between the thick coating and the slip film, effectively preventing the build-up of water pressure on the waterproof coating

## ASSOCIATED PRODUCTS

- Geo-Drain Clip



## TECHNICAL DATA

Material:	High Density Polyethylene (HDPE) Dimpled sheet, Polypropylene Geotextile
Stud Height:	9mm
Roll Size:	12.5m x 2m
Compressive Strength:	400 kN/m <sup>2</sup>
Air volume between studs:	7.9 L/M <sup>2</sup>
Temperature Resistance:	-30°C to +80°C

## SPECIFICATION

NBS Specification  
J40 Flexible Sheet Waterproofing/  
damp proofing  
295 Geocomposite studded cavity  
drainage/venting membrane  
Q37 Green Roofs  
350 Drainage Layer

## PRODUCT CODE

DMS 006

## BENEFITS

**LAYER ONE:** Micro-perforated slip film. This sheet distributes permanent soil pressure. Its micro-perforation allows any water penetrating between the waterproofing and the slip film to escape into the laminated drainage layer.

**LAYER TWO:** Laminated cloth. This cloth absorbs impacts and serves as a backup drainage layer. Even water coming in through an imperfectly mounted edge-sealing strip will be safely drained off.

**LAYER THREE:** Dimpled sheet with self-sealing edge. The dimples that face towards the soil create a maximum-capacity drainage layer that covers the entire surface.

**LAYER FOUR:** Permanent-filtration geotextile. Fused to the dimpled sheet, this filter cloth reliably keeps the dimple structure from clogging up.





# DELTA TERRAXX

Terraxx is a unique drainage protection system/external waterproofing membrane that works in conjunction with Type A External Waterproofing or can simply be used in civil engineering situations. Terraxx is a fused-on geotextile membrane which can be used vertically and/or horizontally.

- Reliably protects and insulates waterproofing layers against mechanical damage
- Withstands extreme compression loads
- High drainage capacity prevents frost damage and encrustations
- Water-vapour pressure is drained away through the structure
- No obstruction by sludge underneath the covering layer
- Good load distribution prevents point loads on the waterproofing layer
- Resultant static building loads lower than those of gravel layers
- Easy and cost-efficient installation.
- Suitable for new and retrofit projects
- Perfect drainage for green roofs, parking decks, walkways, pavements, gravelled flat roofs and foundation slabs
- Assumes the functions of a protection, filtration and seepage layer
- Robust protection and drainage layer
- Patent protected
- Compatible with most customary waterproofing sheets – no additional protective layer required
- Suitable for use in trafficked areas
- Offers acoustic insulation
- Fused-on robust and filter stable geotextile prevents dimple structure from clogging



## SPECIFICATION

NBS Specification  
 J40 Flexible Sheet Waterproofing/  
 damp proofing  
 295 Geocomposite studded cavity  
 drainage/venting membrane  
 J42 Single Layer Polymeric Sheet Roof  
 Coverings  
 385 Filter Layer  
 Q37 Green Roofs  
 350 Drainage Layer  
 R16 Groundwater Pressure Relief  
 Drainage  
 360 Polyethylene Sheet for Filter Drain  
 Capping

## PRODUCT CODE

DMS 025

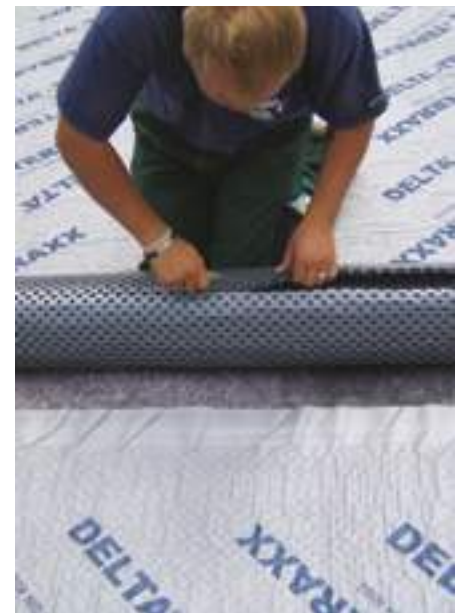

## TECHNICAL DATA

Material:	High Density Polyethylene (HDPE) Dimpled sheet, Polypropylene Geotextile
Stud Height:	9mm
Roll Size:	12.5m x 2.4m
Compressive Strength:	400 kN/m <sup>2</sup>
Air volume between studs:	7.9 L/M <sup>2</sup>
Temperature Resistance:	-30°C to +80°C

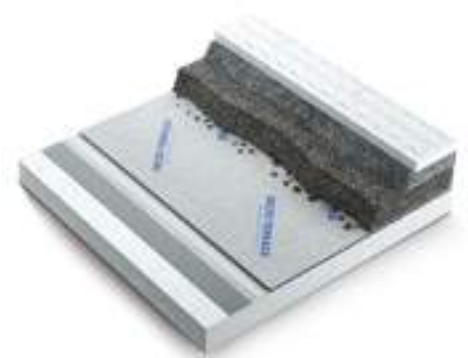

# DELTA FLORAXX TOP

Floraxx Top is a unique drainage protection system/reservoir drainage membrane that works in conjunction with Type A External Waterproofing or can simply be used in Green roof Constructions. Floraxx Top is a water-retaining drainage sheet with an integrated geotextile which provides a perfect solution for green roofs. The innovative octagonal dimples in Floraxx Top have been developed specifically for green roofs. Thanks to this unique dimple structure and its innovative material Floraxx

## TOP'S FUNCTIONS INCLUDE:

- Drainage
- Water Storage and
- Filtration

Floraxx Top is the optimum solution for flat roofs which are to be extensively and intensively planted to provide green spaces atop buildings. Floraxx Top is able to sustain the heaviest of loads safely and provides an extremely serviceable and economical foundation for green roofs.

- One solution for drainage, water storage and filtration
- Innovative octagonal dimples for outstanding compressive strength
- Suitable for new and retrofit projects
- Waterproof layer resists root penetration
- Protective layer conforming to FLL guidelines for green roofs
- Fused on geotextile eliminates one laying operation
- Substrate may be applied and planted immediately after laying
- Forms a consistent homogenous surface without the problems caused by loose cloth layers slipping, shifting or being blow about by the wind
- Easy Application
- Patent protected



## TECHNICAL DATA

Material:	High Density Polyethylene (HDPE) Dimpled sheet, Polypropylene Geotextile
Stud Height:	20mm
Air Gap:	14 L/m <sup>2</sup>
Roll Size:	10m x 2m
Compressive Strength:	200 kN/m <sup>2</sup>
Air volume between studs:	200 kN/m <sup>2</sup>
Temperature Resistance:	7.9 L/M <sup>2</sup>
Lateral water permeability:	10 x 10 <sup>-3</sup> m <sup>2</sup> /s (10 L/s · m) (EN ISO 12958)
Vertical Water permeability:	1.2 L/m <sup>2</sup> · s
Water Storage Capacity:	7 L/m <sup>2</sup>

## SPECIFICATION

NBS Specification  
Q37 Green Roofs  
355 Combined Layers

## PRODUCT CODE

DMS 205



# DELTA NP DRAIN

Delta NP Drain is a unique drainage protection system/external waterproofing membrane that works in conjunction with Type A External Waterproofing on retaining walls, basement structures and decks and terraces as well being used in civil engineering situations. With its special filtration cloth, this dimpled sheet features an outstanding compressive strength of about 150 kN/m<sup>2</sup>, acting as a reliable drainage system supporting walls of all type. NP Drain can be used in vertical and/or horizontal in application.

- High Compressive Strength
- Suitable for new and retrofit projects
- An effective barrier to water and water vapour
- Easy Application
- Patent protected
- Fused-on robust and filter stable geotextile prevents dimple structure from clogging
- Compression-resistant waterproofing
- Rot proof
- High Drainage Capacity
- Consistently relieves hydrostatic pressure on waterproofing layer
- Features a geotextile layer which filters out fine soil particles ensuring a constant flow of water down to the drainage pipe
- Awarded the "Avis Technique du CSTB no. 7/03-1367 Test Certificate"

## H2 ASSOCIATED PRODUCTS

- Delta Tape
- Capping Profile
- Geo Drain Clips



## SPECIFICATION

NBS Specification  
J40 Flexible Sheet Waterproofing/  
damp proofing  
295 Geocomposite studded cavity  
drainage/venting membrane  
Q37 Green Roofs  
350 Drainage Layer

## PRODUCT CODE

DMS 022



## TECHNICAL DATA

Material:	High Density Polyethylene (HDPE) Dimpled sheet, Polypropylene Geotextile
Stud Height:	8mm
Roll Size:	12.5m x 3m, 20m x 2m
Compressive Strength:	150 kN/m <sup>2</sup>
Air volume between studs:	7g L/M <sup>2</sup>
Temperature Resistance:	-30°C to +80°C
Drainage rate:	2.25 l/s · m
Drainage Capacity:	1.0 l/s · m

# TESTING & MAINTENANCE

## PRINCIPLES OF MAINTAINABILITY DURING CONSTRUCTION

Maintainability of waterproofing systems should be encouraged and facilitated during the design stage of a project. Maintainability is the degree to which allows safe, quick and easy replacement of component parts to a system. The importance of maintainability being designed into a project from concept stage is vital, as a lack of system maintainability will increase the building life-cycle costs, from operation to maintenance expenses.

Detail considerations during design stage for maintainability:

- Type and form of construction
- Site Inspection
- Design compliance
- Structural movement
- Drainage arrangements
- Resilience
- Accessibility for remedy or maintenance
- Free lime
- Type of surface
- Concrete surface condition
- Moisture
- Temperature
- Contaminates
- Surface preparation prior (such as treatments, coatings and laitance)

## FLOOD/INTEGRITY TESTING

The integrity of the waterproofing system should be checked and inspected on installation and immediately upon completion. If there is a delay before final handover or the laying of permanent coverings, a second test is strongly recommended. Test objectives should be decided upon prior to the method of testing.

There are 3 methods for integrity testing a waterproofed deck/complete roof system:

- Radar and Hydrogen Ion Detection
- Flood Testing
- Thermal Imaging (Thermography).
- Holiday testing (ISO @ NACE Compliant Products). This checks coating thickness's and general material integrity.

The efficacy of all methods for integrity testing depend upon:

- Knowledge of the functioning and calibration of equipment
- Knowledge of the roofing specification and the structural support
- Experience of the operator

## FREE LIME/CALCIUM HYDROXIDE

Lime weeping/excess free lime leaching is caused by water leaking through concrete and dissolving calcium hydroxide from the matrix. On contact with the atmosphere, calcium hydroxide reacts with carbon dioxide to form calcium carbonate, which is precipitated on the surface when the water evaporates, generally at cracks or construction joints. If the correct waterproofing system has been installed water pooling/free lime/calcium hydroxide should not be seen. When water pooling/free lime/calcium hydroxide is present this is due to a leak in the waterproofing system. We recommend a Waterproofing Design Specialist should be consulted to design a remedial repair if these are present.

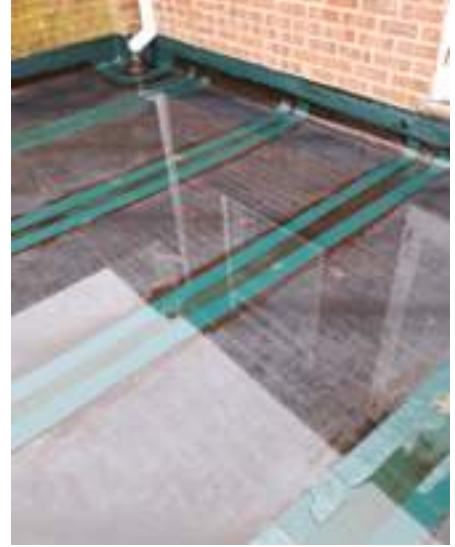

# DETAILED DRAWINGS

## RC DECK DETAIL WITH BRICKWORK WALL

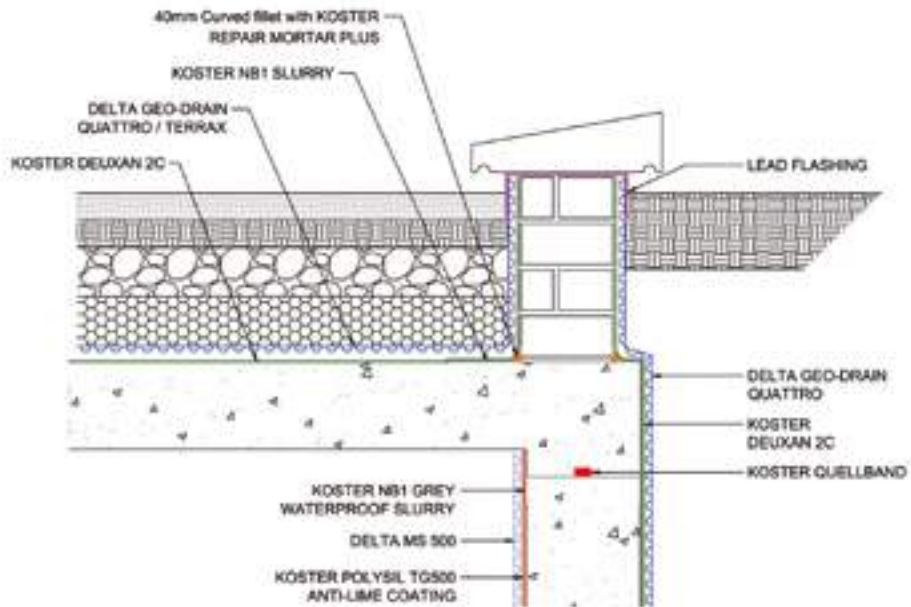

## RC DECK DETAIL WITH BRICKWORK WALL

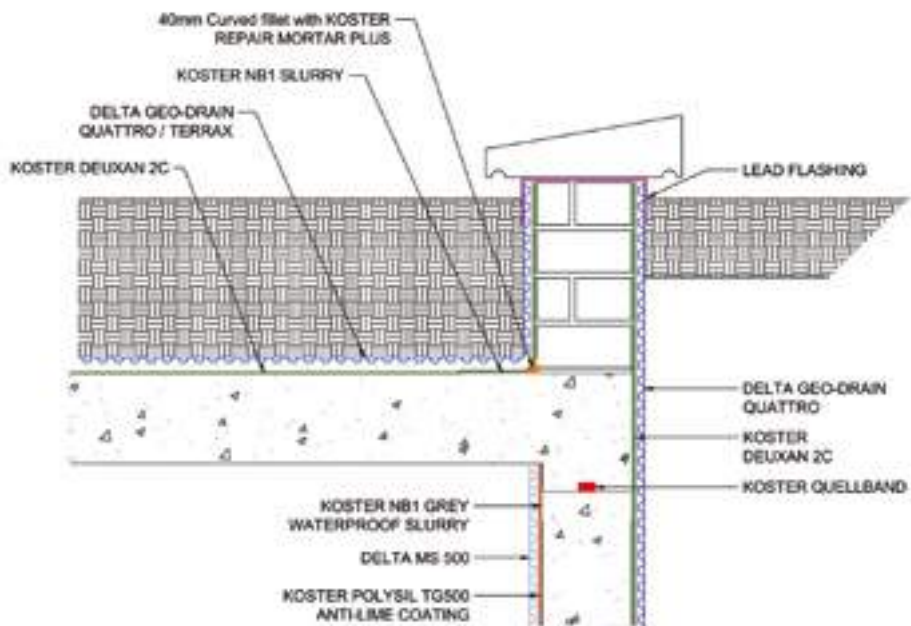

# DETAILED DRAWINGS

## WATERPROOFING GARDEN DECK

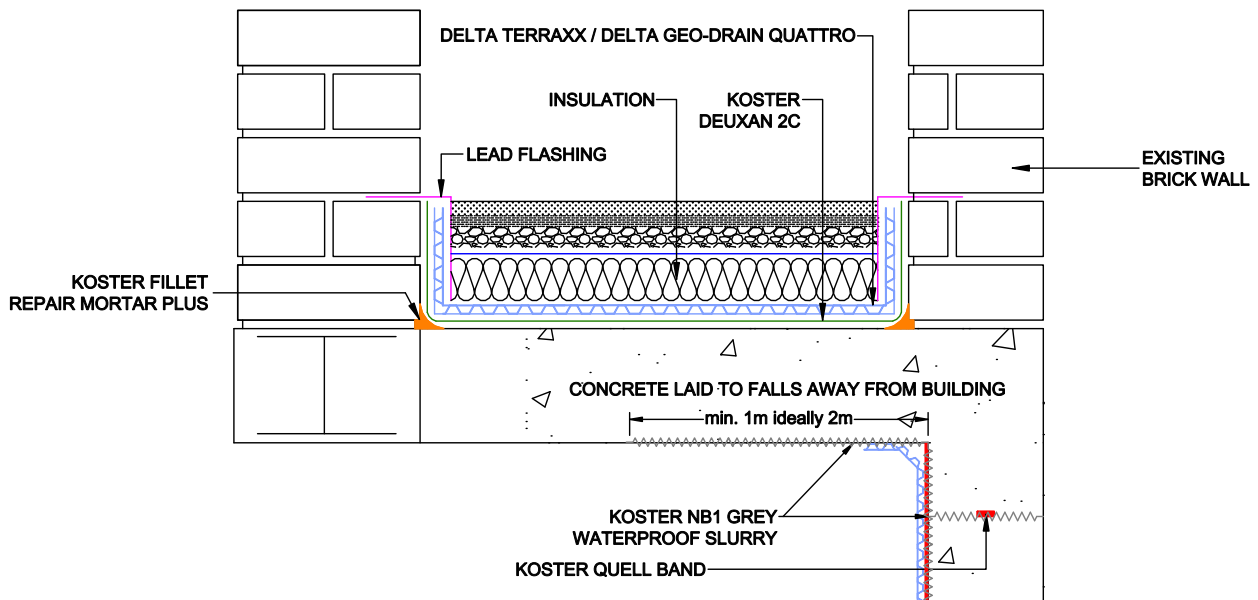

## DELTA TERRAXX HORIZONTAL GARDEN DECK

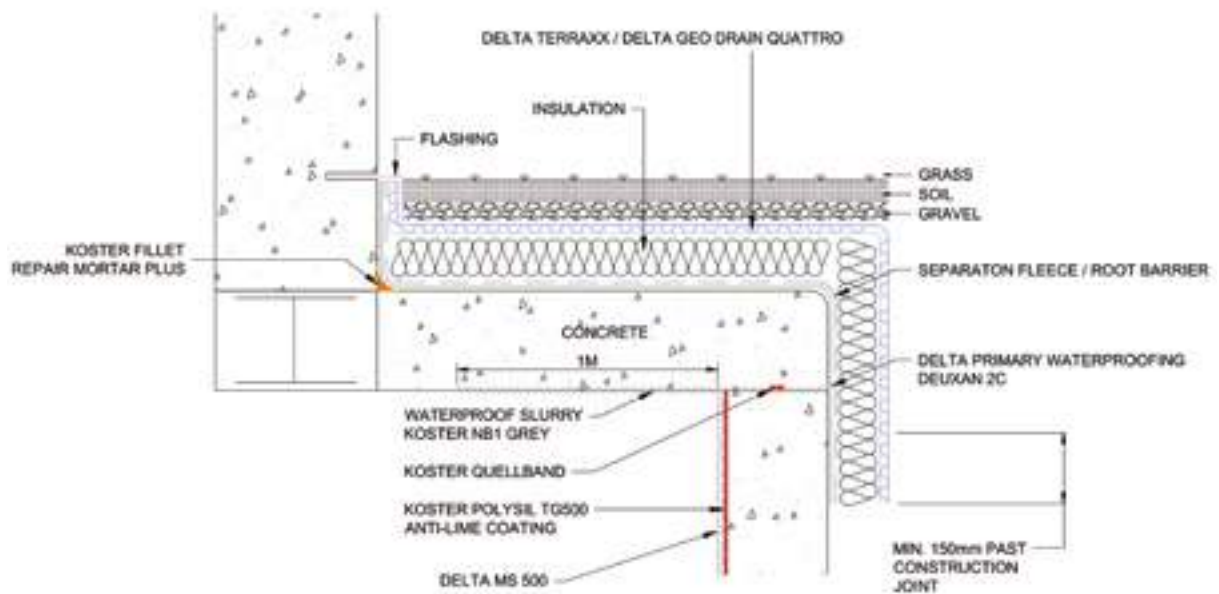

# DETAILED DRAWINGS

## EXPANSION - MOVEMENT JOINT SEALING

JOINT SEALANT - HEIGHT: WIDTH RATIO 2:1

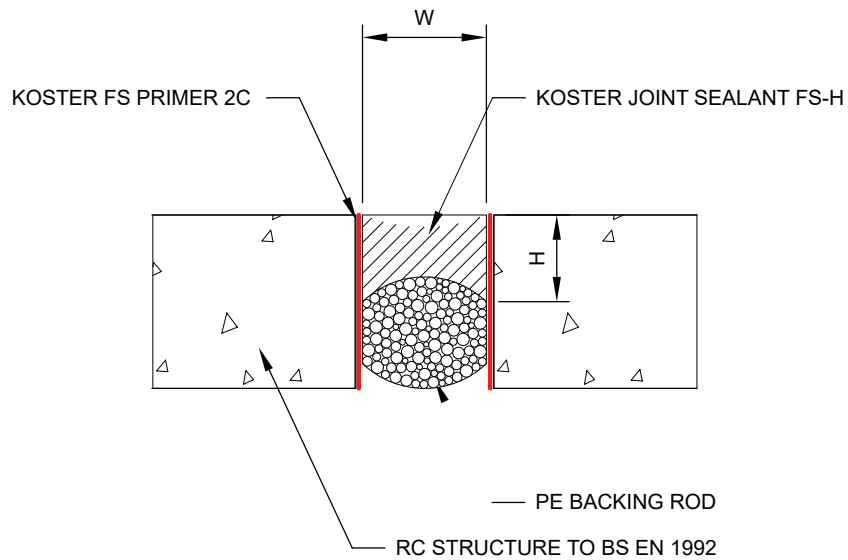

## EXPANSION - MOVEMENT JOINT SEALING

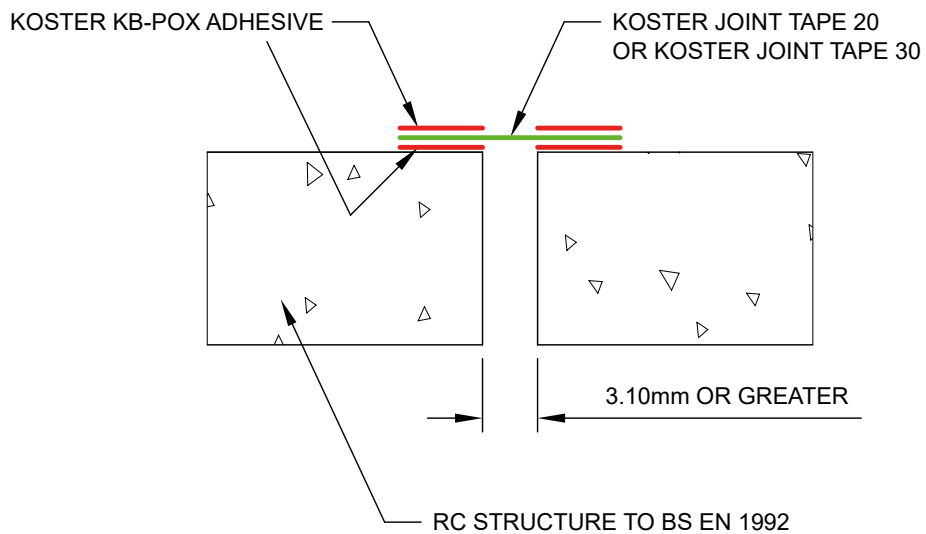

# DETAILED DRAWINGS

## ROOF DECK GULLY DETAILING

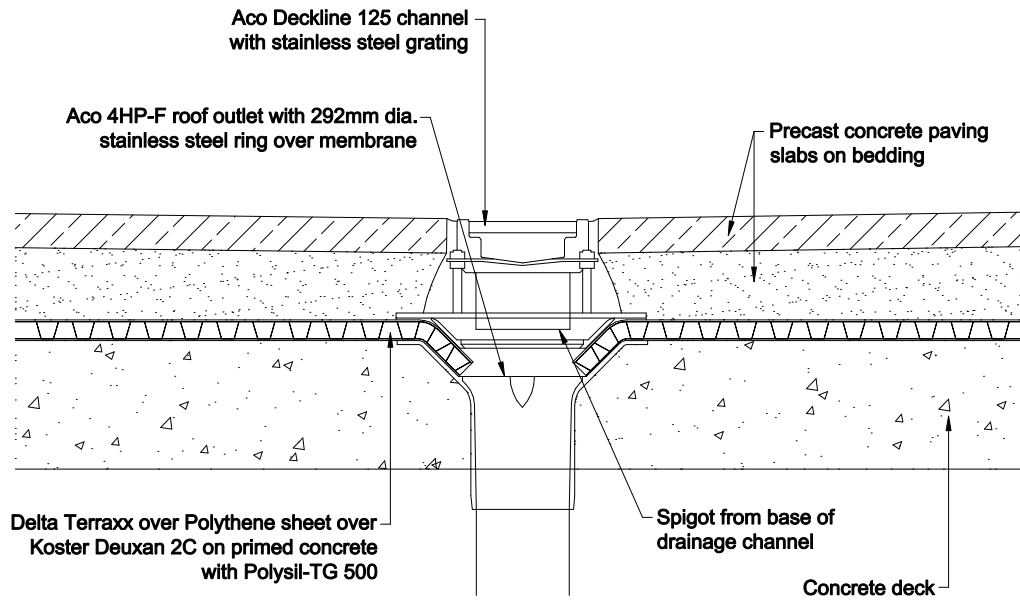

## ROOF LIGHT DETAIL

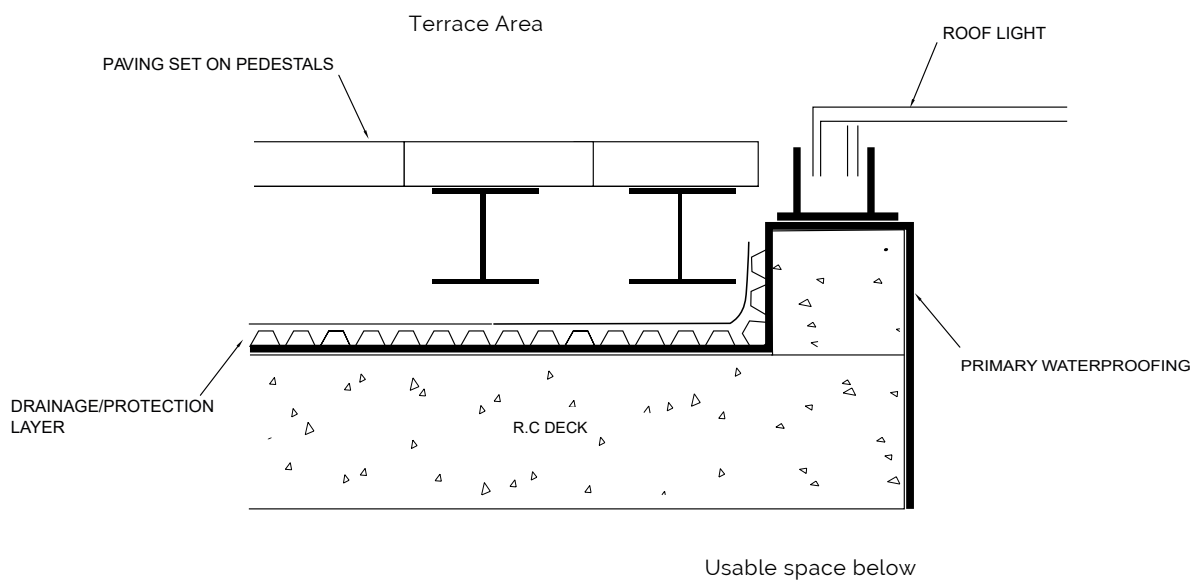



# DETAILED DRAWINGS

## EXTERNAL DECKS/TERRACES/BALCONIES

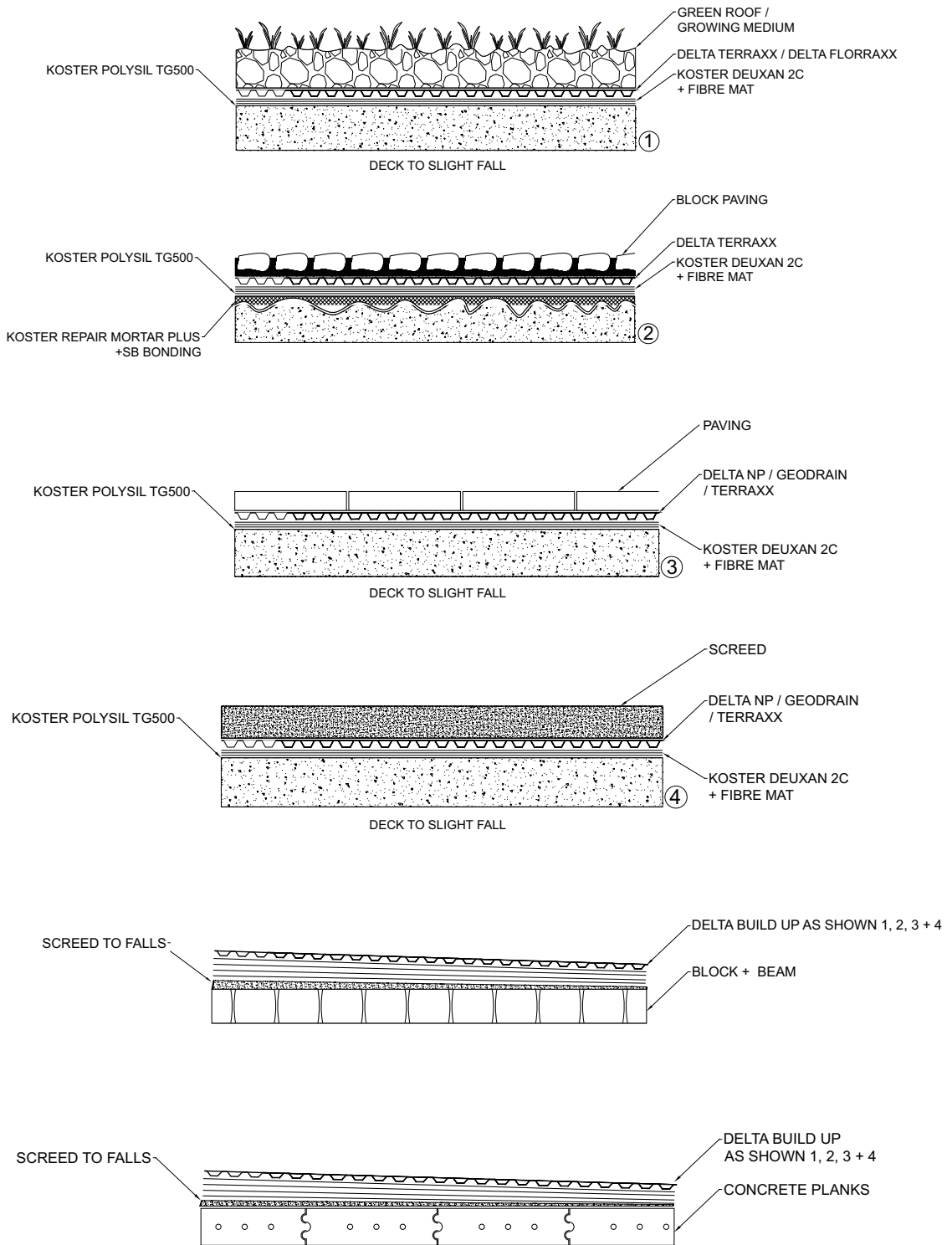

# DELTA APPLICATION

## WHICH DELTA SYSTEM FITS WHAT APPLICATION?

APPLICATION	FLORAXX	FLORAXX-TOP	TERRAXX	NP DRAIN	GEO-DRAIN QUATTRO
Green Roof					
Warm Roof					
Intensive herbaceous Cover		✓	✓		
Extensive herbaceous Cover		✓	✓	✓	✓
Inverted Roof					
Intensive herbaceous Cover	✓	✓			
Extensive herbaceous Cover	✓	✓		✓	✓
Roof Decks Used for Traffic					
Warm Roof					
Walkable Surface			✓	✓	✓
Drivable Surface			✓	✓	✓
Inverted Roof					
Walkable Surface	✓			✓	✓
Drivable Surface	✓			✓	✓
Podium Deck	✓	✓	✓	✓	✓
Terraces & Balconies			✓	✓	✓
Car Park			✓	✓	✓
Cold Roof			✓	✓	✓
Blue Roof	✓	✓	✓	✓	✓
Hybrid Roof	✓	✓	✓	✓	✓

# KOSTER APPLICATION

## WHICH KOSTER SYSTEM FITS WHAT APPLICATION?

APPLICATION	DEUXAN 2C	NB 4000	KOSTER 21	FLEX FOIL	KSK	KBE LIQUID
Green Roof						
Warm Roof						
Intensive herbaceous Cover	✓	✓	✓	✓	✓	✓
Extensive herbaceous Cover	✓	✓	✓	✓	✓	✓
Inverted Roof						
Intensive herbaceous Cover	✓	✓	✓	✓	✓	✓
Extensive herbaceous Cover	✓	✓	✓	✓	✓	✓
Roof Decks Used for Traffic						
Warm Roof						
Walkable Surface	✓	✓	✓	✓	✓	✓
Drivable Surface	✓	✓	✓	✓	✓	✓
Inverted Roof						
Walkable Surface	✓	✓	✓	✓	✓	✓
Drivable Surface	✓	✓	✓	✓	✓	✓
Podium Deck	✓	✓	✓	✓	✓	✓
Terraces & Balconies	✓	✓	✓	✓	✓	✓
Car Park	✓	✓	✓	✓	✓	✓
Cold Roof	✓	✓	✓	✓	✓	✓
Blue Roof	✓	✓	✓	✓	✓	✓
Hybrid Roof	✓	✓	✓	✓	✓	✓

